

Ġ3.3.4

Id-dawl elettriku jeħtieġ ma naħluhx; kif nużawh sew

A. Intervista lil tad-dar.

X'taġħmlu biex tiffrankaw l-elettriku?







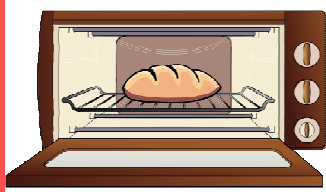
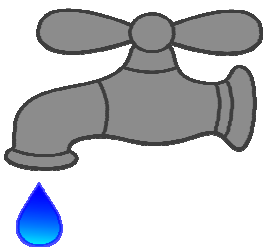

1. Nitfu d-dawl meta jkollna d-dawl tax-xemx.	
2. Nitfu d-dawl meta noħorgu minn ġo kamra.	
3. Nużaw bozoz 'energy saving'.	
4. Ma nħallux it-televixin stand-by.	
5. Nitfu ċ-ċarġer tal-mowbajl meta ma jkollniex bżonnu.	
6. Ma nħallux il-bieba tal-frigg miftuħa.	
7. Nitfu l-geyser bil-lejl.	
8. Nużaw is-solar water heater.	
9. Nużaw is-solar panels.	
10. Nimlew il-kitla biss kemm ikun hemm bżonn.	

Għal kull  aġħti punt. Kemm -il punt għandkom? /10

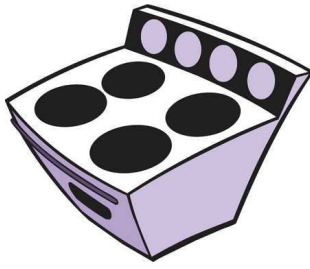
Ms. Claire Amato

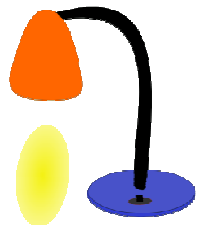
B. Liema minn dawn l-oġgetti jaħdmu bid-dawl elettriku? Qasqas u waħħal.

 <p>it-televixin</p>	 <p>il-forn tad-dawl</p>	 <p>il-vit tal-ilma</p>	 <p>l-imqass</p>
 <p>il-kuker tal-gass</p>	 <p>il-lampa tal-gass</p>	 <p>il-lampa tad-dawl</p>	 <p>il-blower</p>

<i>Għandhom bżonn id-dawl elettriku</i>	<i>M'għandhomx bżonn id-dawl elettriku</i>

Ms. Claire Amato

Ċ. Imla bil-kulur **biss** dawk l-oġgetti li ma jaħdmux **jekk imur id-dawl.**

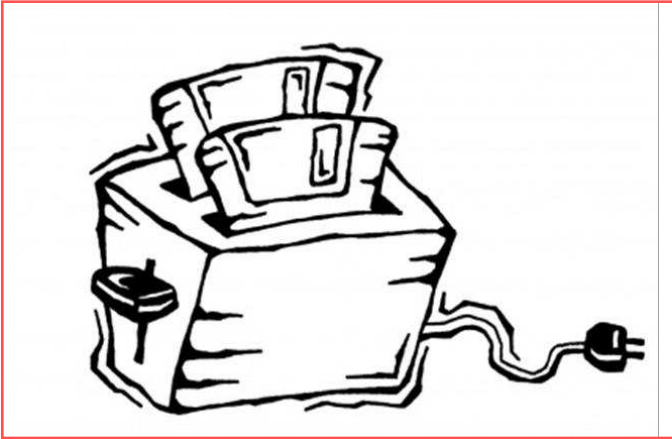

it-towster

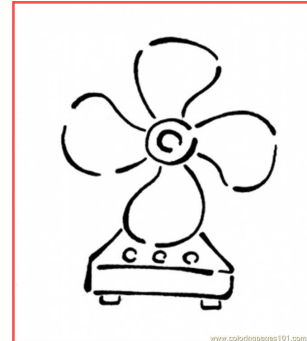

il-fann

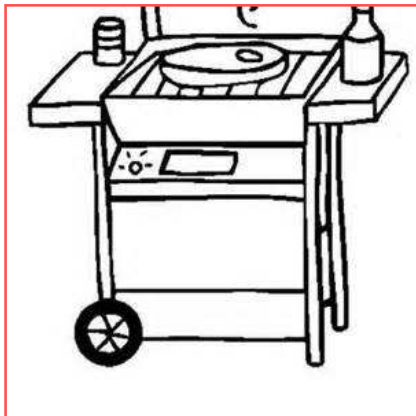

il-barbikju tal-gass

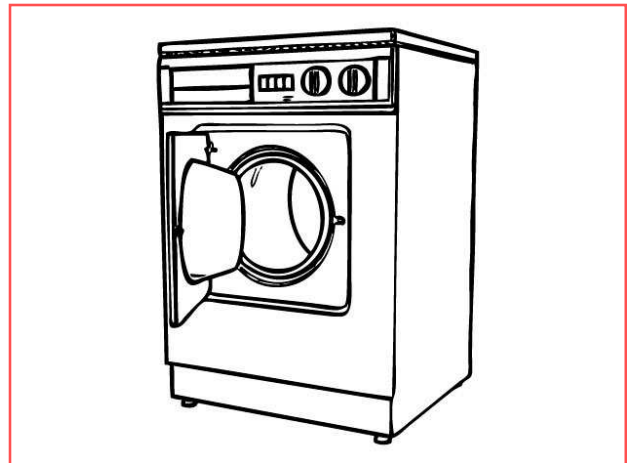

il-magna tal-ħasil tal-ħwejjeg

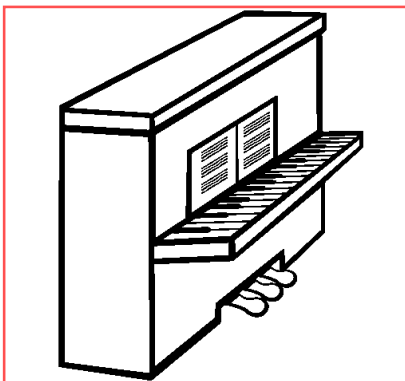

il-pjanu

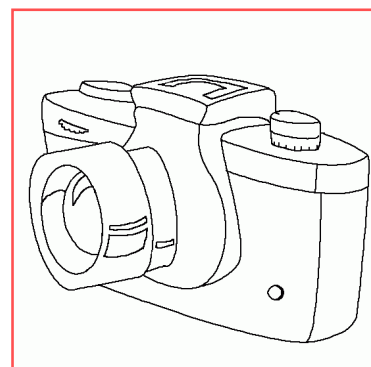

il-kamera tar-ritratti

Ms. Claire Amato

D. Kif se naflu inqas dawl l-iskola?

Fares lejn l-istampi u ikteb frazi jew sentenza xierqa bħall-eżempju:

1.

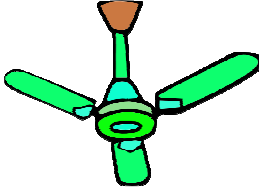

Nitfu l-fann qabel ma noħorgu mill-klassi.

2.



3.



4.



5.

